



OKE Kunststofftechnik GmbH & Co. KG
Am Willersberg 231 / 98663 Ummerstadt / GERMANY

T +49 36871 2740
F +49 36871 27419
info@oke.de

OKE.DE

PRACTICAL EXAMPLE: ARMCHAIR



MÖBELTECH- NIK/FURNITURE TECHNOLOGY

Wir geben Ideen Raum, unsere Kunden inspirieren. Viele Ideen der Möbelhersteller sind ohne unsere Produkte kaum zu realisieren. Wir entwickeln und produzieren Befestigungslösungen und Design-Elemente für die unterschiedlichsten Möbel. Unsere Bauteile steigern die Prozesssicherheit in der Fertigung, verleihen bestimmte Konturen und ermöglichen neue Konstruktionen. Diese Kreativität sowie unser weltweites Händler- und Beraternetzwerk sind der Grund, weshalb alle namhaften Möbelhersteller OKE vertrauen.

Lassen Sie sich mit unserem Anwendungskatalog ORIGINALS BY OKE inspirieren - mit weit über 100 Anwendungsbeispielen für die Möbelindustrie.

We make room for ideas, inspire our customers. Many of the furniture manufacturers ideas can only be put into practice with our little helpers. We develop and produce attaching solutions and design parts for the most diverse furnitures. Our components enhance process security in the production of our customers, give contours and enable new constructions. This creativity as well as our worldwide network of wholesalers and consultants are the reason why all major furniture manufacturers trust in OKE.

Be inspired with our application catalogue ORIGINALS BY OKE for new ideas with far more than 100 examples of applications for the furniture industry.



VIELE WEITERE IDEEN UND
ANWENDUNGEN IN UNSEREM
KATALOG ORIGINALS BY OKE./
MANY MORE IDEAS AND
APPLICATIONS IN OUR CATALOGUE
ORIGINALS BY OKE.

04

RÜCKENLEHNE/
BACK REST



04 →

4370-033
3604-000
2785-046
1471-040
2015-606

05 →

5509-000
5009-220
2140-071
2023-M400
2023-510

06

SITZFLÄCHE/
SEAT



06 →

4900-100
4370-033
3694-019

07 →

2040-000
3604-000
5009-160

08 →

1471-040
27840-120
2271-000
2023-510

09

ALTERNATIVE
BLENDE/ALTERNATIVE COVER



09 →

5509-000
2140-071
5011-150

10 →

3074-150
5011-302
3074-200
2298-000
2297-000

11 →

5111-070
4551-001
3012-000
2371-000

12

ARMLEHNE/
ARM REST



12 →

1939-000
2142-050
2109-051
5009-100

13 →

4247-040
5111-100
2023-S000
2023-510

14 →

1107-150
5509-000

15

HOLZRAHMEN/
WOODEN FRAME

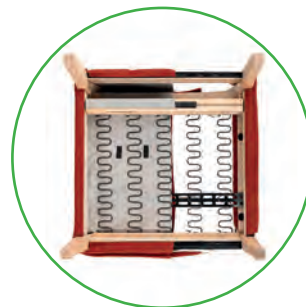

15 →

2288-000
3302-999
5009-100
2271-000
2023-510

16 →

2040-000C
3604-000
3074-200

17 →

2298-000
2297-000
1107-150



JETZT OKE-PROFILE BESTELLEN UNTER
INFO@OKE.DE ODER BEI IHREM ANSPRECH-
PARTNER./ORDER OKE PROFILES NOW
AT INFO@OKE.DE OR FROM YOUR LOCAL
CONTACT.

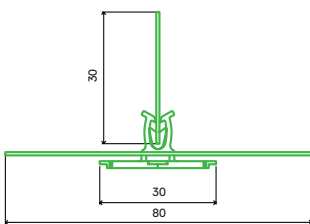
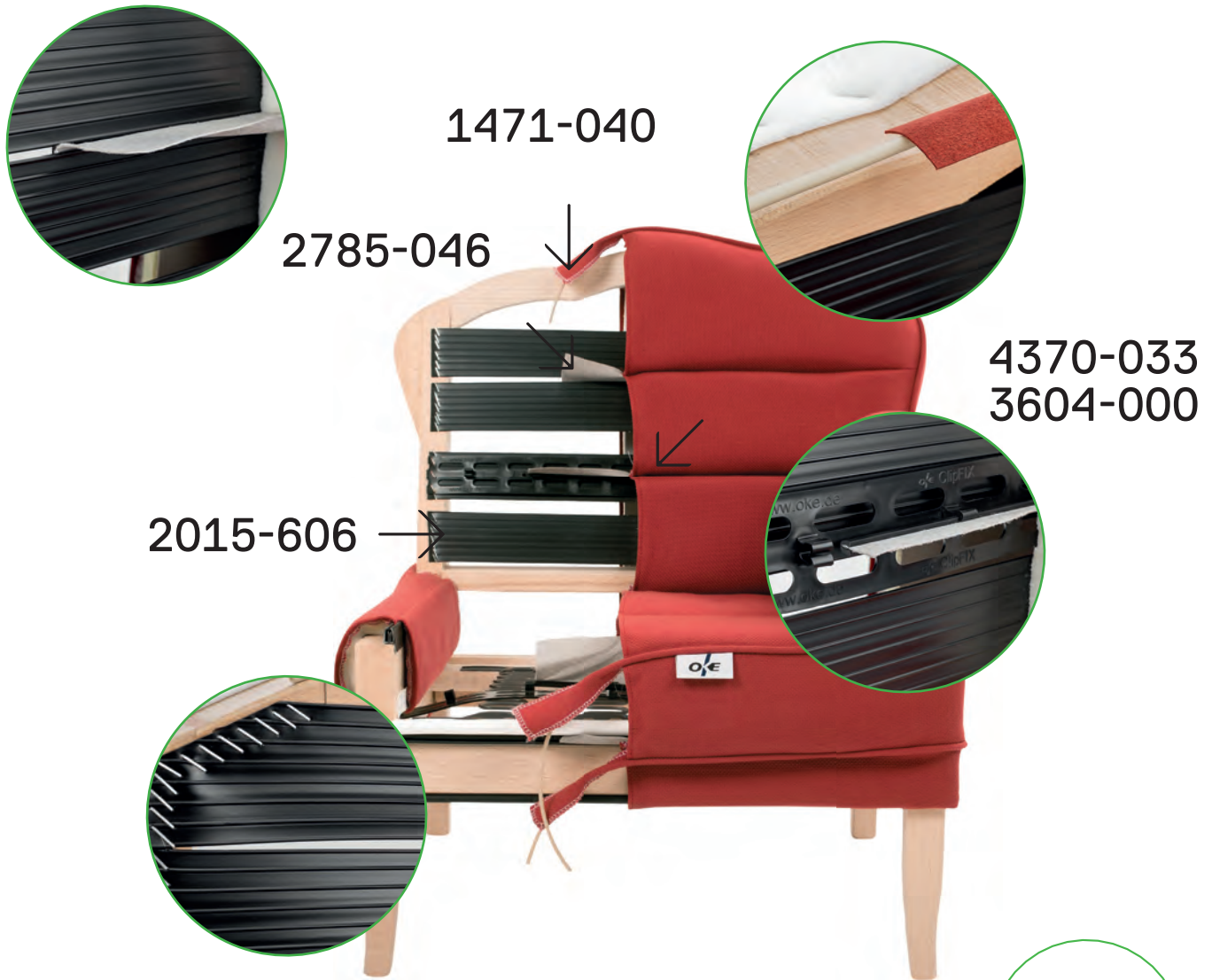

4370-033
3604-000

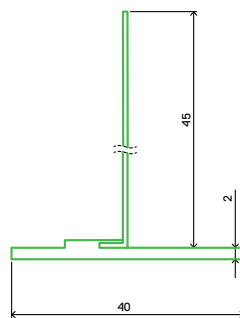

2785-046

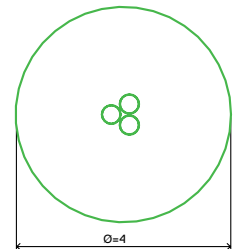

1471-040

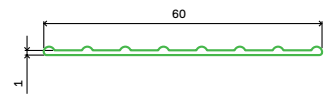

2015-606

NO.	BESCHREIBUNG/DESCRIPTION
4370-033	ClipFix ClipFix
3604-000	TieDown für schnelle Verarbeitung TieDown for fast processing
2785-046	Einzug-Steckstreifen ohne Gegenleiste Fluting Strip without counter-bar

NO.	BESCHREIBUNG/DESCRIPTION
1471-040	Kunststoffschnur Piping cord
2015-606	Klammerstreifen mit Führungsgrillen Stapling Strip with guide grooves

2023-M400
2023-510

5009-220

2140-071

5509-000

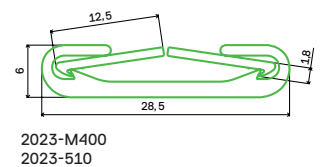
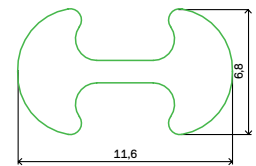
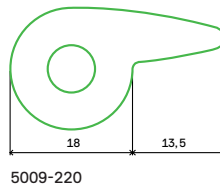
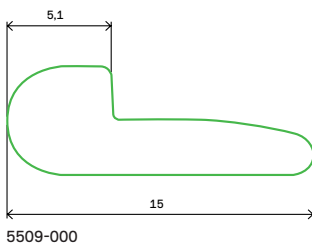
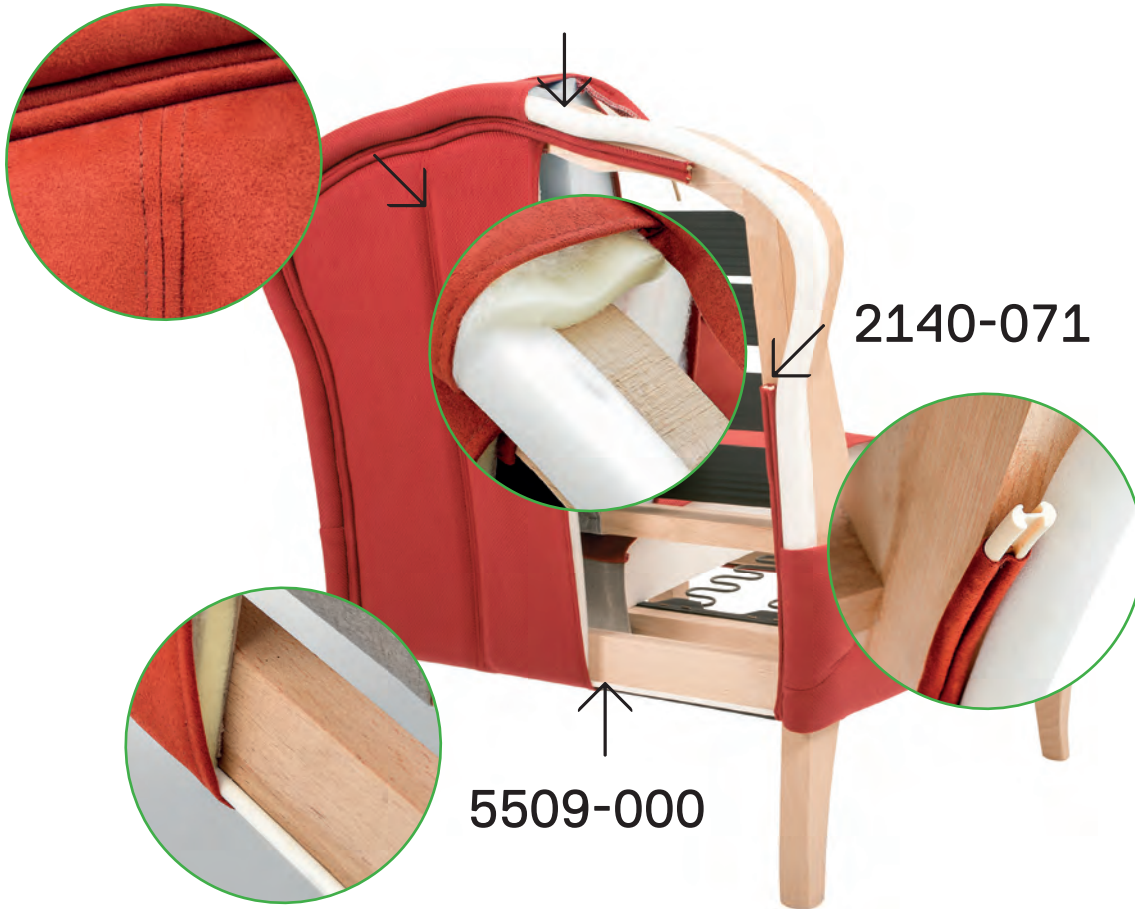

NO.	BESCHREIBUNG/DESCRIPTION
5509-000	Schlauchkeder mit dezentem Kantenschutz Edge Trim with subtle edge protection
5009-220	Schlauchkeder Edge Trim
2140-071	Blindnahtprofil Blind seam profile

NO.	BESCHREIBUNG/DESCRIPTION
2023-M400	Doppelverschlussprofil Double lock profile
2023-510	Gegenleiste Counter-bar

4370-033
3694-019



4900-100

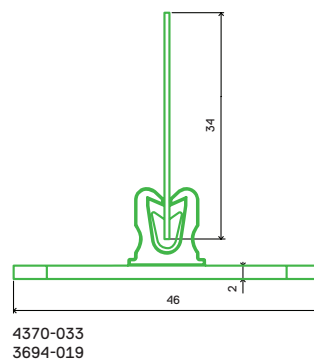
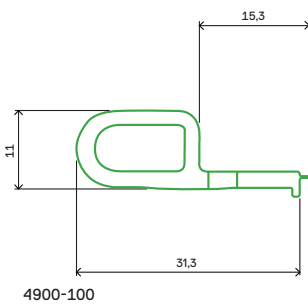

NO.

BESCHREIBUNG/DESCRIPTION

4900-100



Clip Strip Plus
Clip Strip Plus

NO.

BESCHREIBUNG/DESCRIPTION

4370-033



ClipFix
ClipFix

3694-019



TieDown für feste Verbindung
TieDown for fixed connection



2040-000
3604-000

5009-160

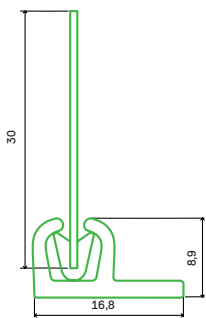

2040-000
3604-000

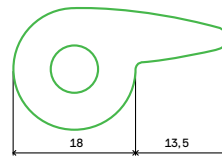

5009-160

NO.	BESCHREIBUNG/DESCRIPTION
2040-000	Clip Profil mit Fahne Clip profile with flange
3604-000	TieDown für schnelle Verarbeitung TieDown for fast processing

NO.	BESCHREIBUNG/DESCRIPTION
5009-160	Schlauchkeder Edge Trim

2271-000
2023-510

27840-120

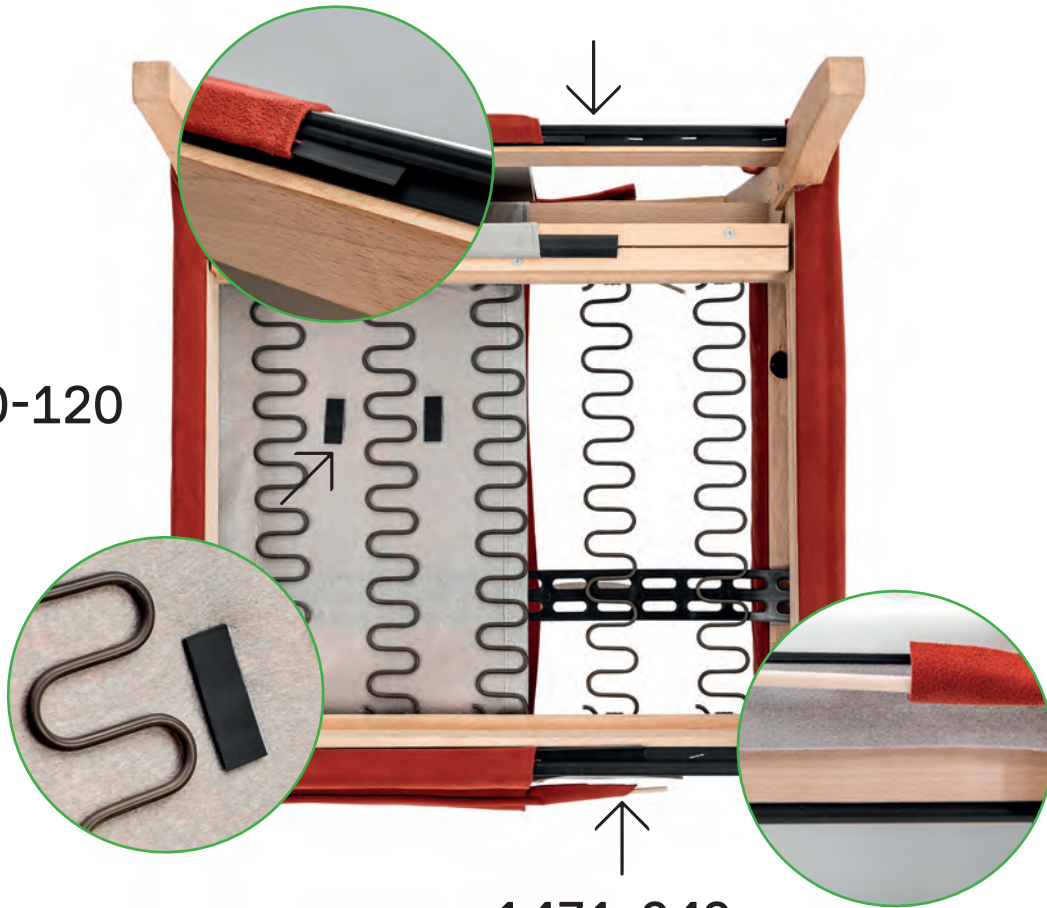

1471-040

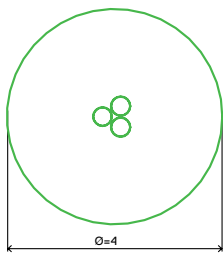

1471-040

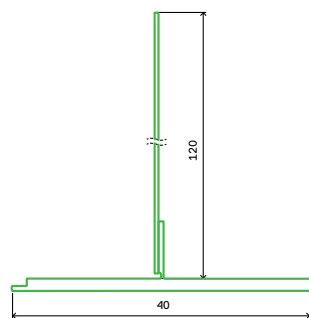

27840-120

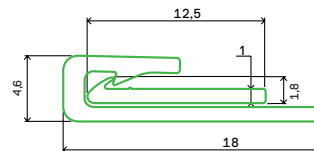

2271-000
2023-510

NO. BESCHREIBUNG/DESCRIPTION

1471-040

Kunststoffschnur
Piping cord

27840-120

Punktabheftsteg
Single tufting strip

NO.

BESCHREIBUNG/DESCRIPTION

2271-000

Verschlussprofil mit Widerhaken
Lock profile with barb

2023-510

Gegenleiste
Counter-bar

5011-150

2140-071

5509-000

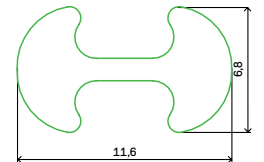

2140-071

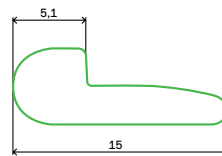

5509-000

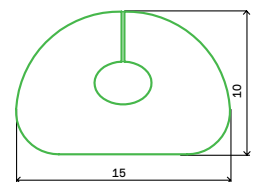

5011-150

NO.	BESCHREIBUNG/DESCRIPTION
5509-000	Schlauchkeder mit dezentem Kantenschutz Edge Trim with subtle edge protection

2140-071	Blindnahtprofil Blind seam profile
----------	---------------------------------------

NO.	BESCHREIBUNG/DESCRIPTION
5011-150	Schlauchkeder Edge Trim

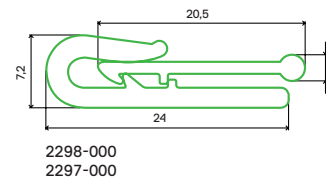
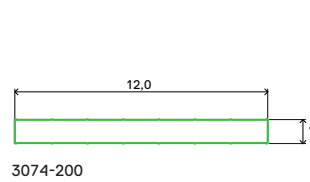
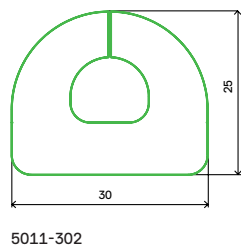
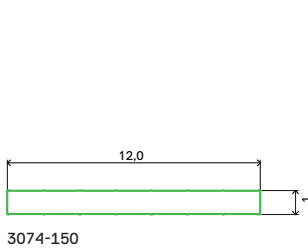
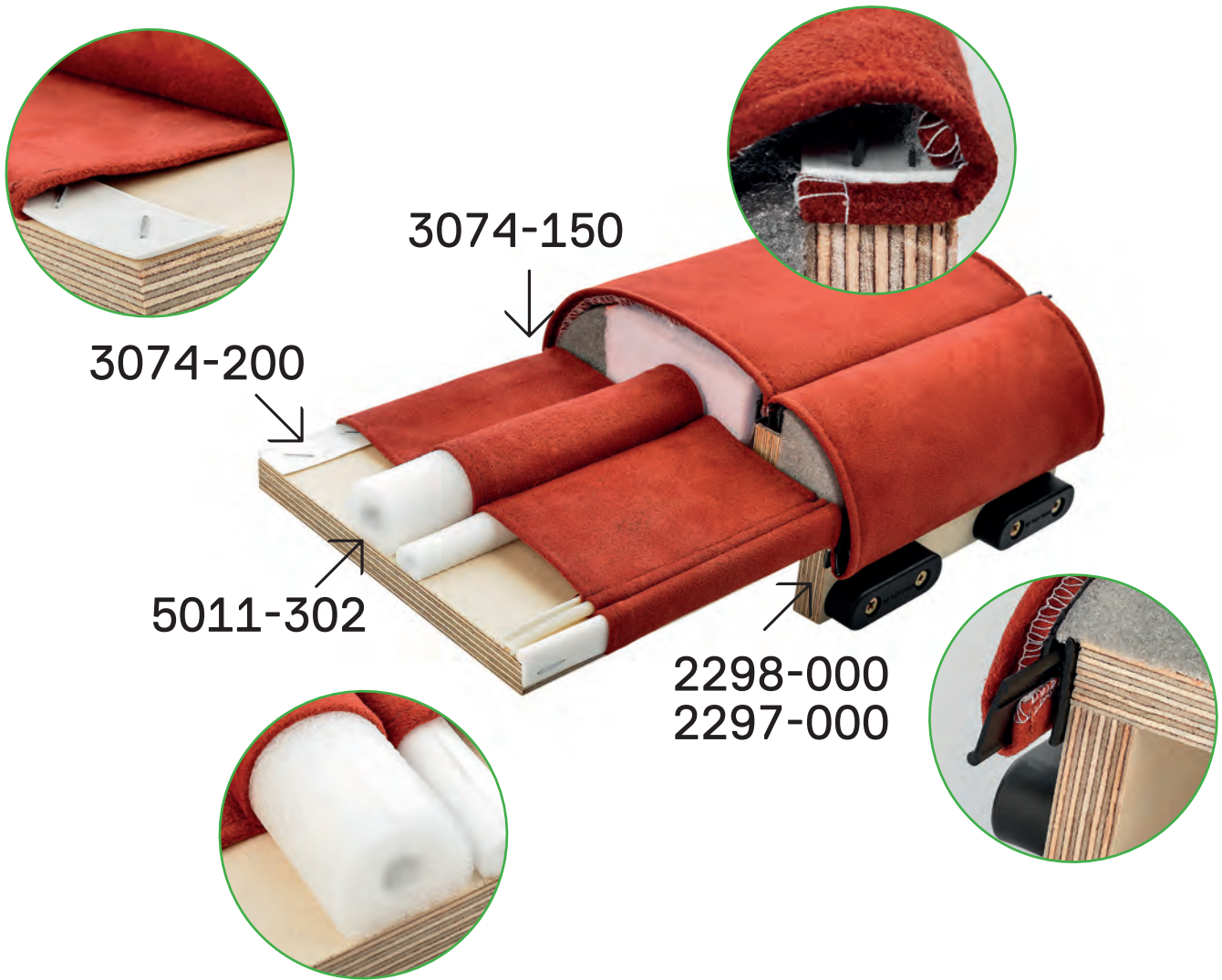

NO.	BESCHREIBUNG/DESCRIPTION
3074-150	Klammerstreifen mit Führungsrillen Stapling Strip with guide grooves
5011-302	Schlauchkeder Edge Trim
3074-200	Klammerstreifen mit Führungsrillen Stapling Strip with guide grooves

NO.	BESCHREIBUNG/DESCRIPTION
2298-000	Verschlussprofil mit Widerhaken Lock profil with barb
2297-000	Gegenleiste mit Kugel Counter-bar with ball

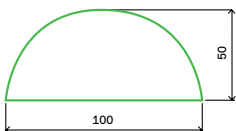
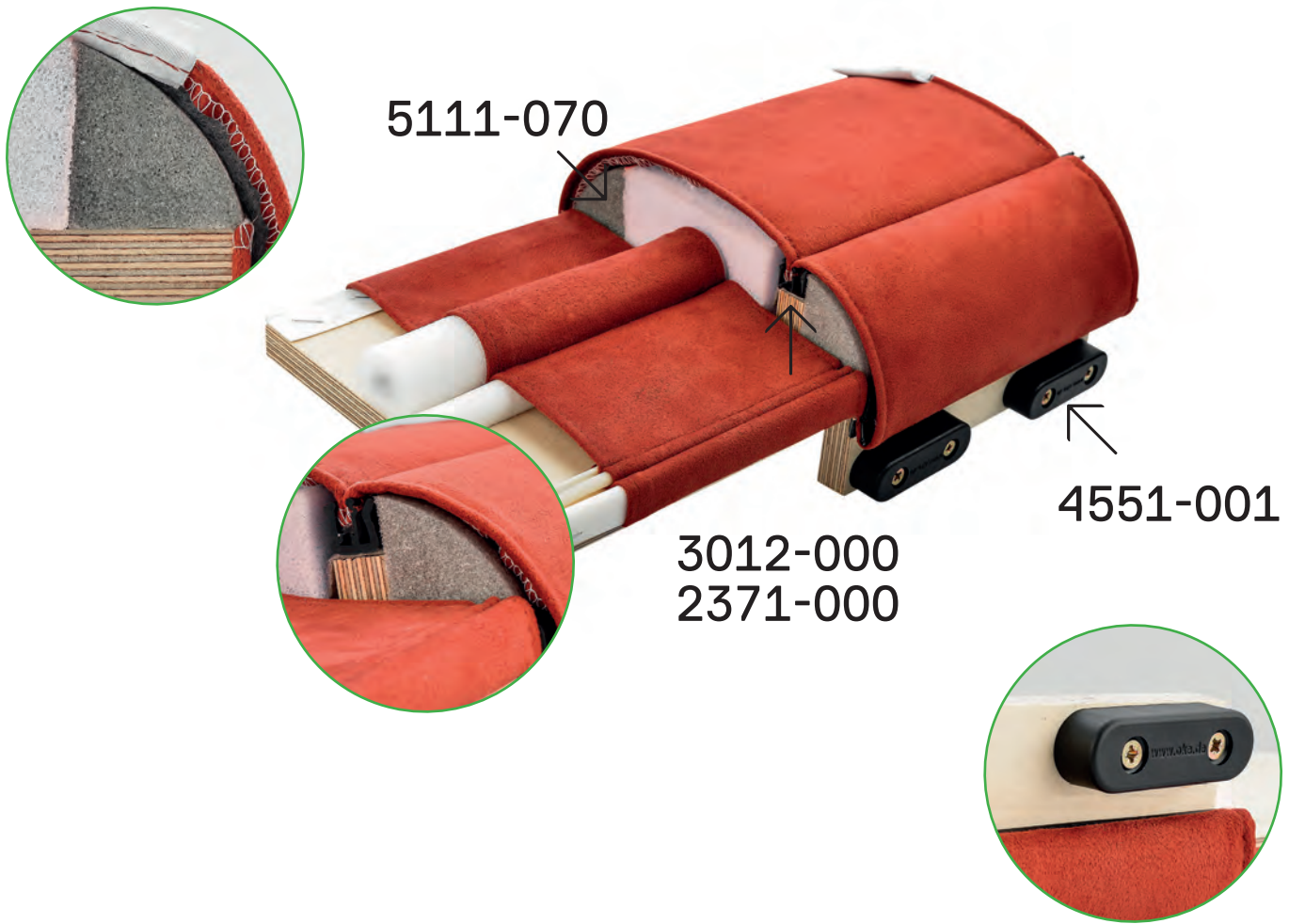

5111-070

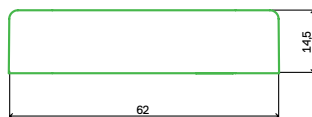

4551-001

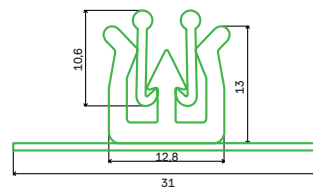

3012-000
2371-000

NO.	BESCHREIBUNG/DESCRIPTION
5111-070	FoamFlex Light FoamFlex Light
4551-001	Stuhlgleiter Chair glide

NO.	BESCHREIBUNG/DESCRIPTION
3012-000	Doppelverschlussprofil Double lock profile with non-woven
2371-000	Gegenleiste Counter-bar

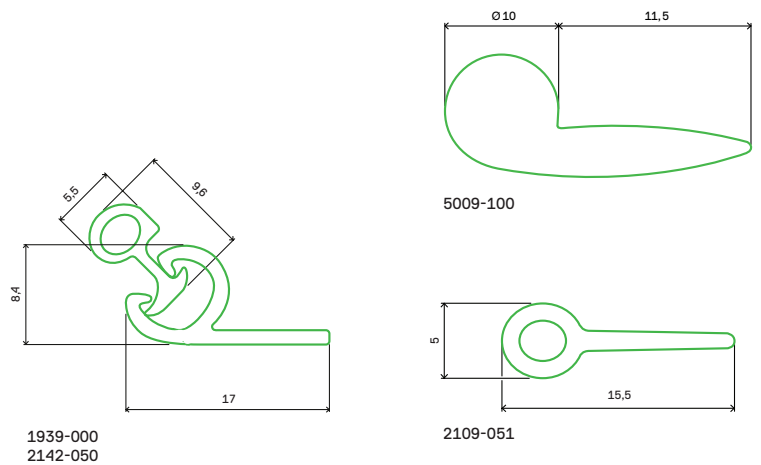
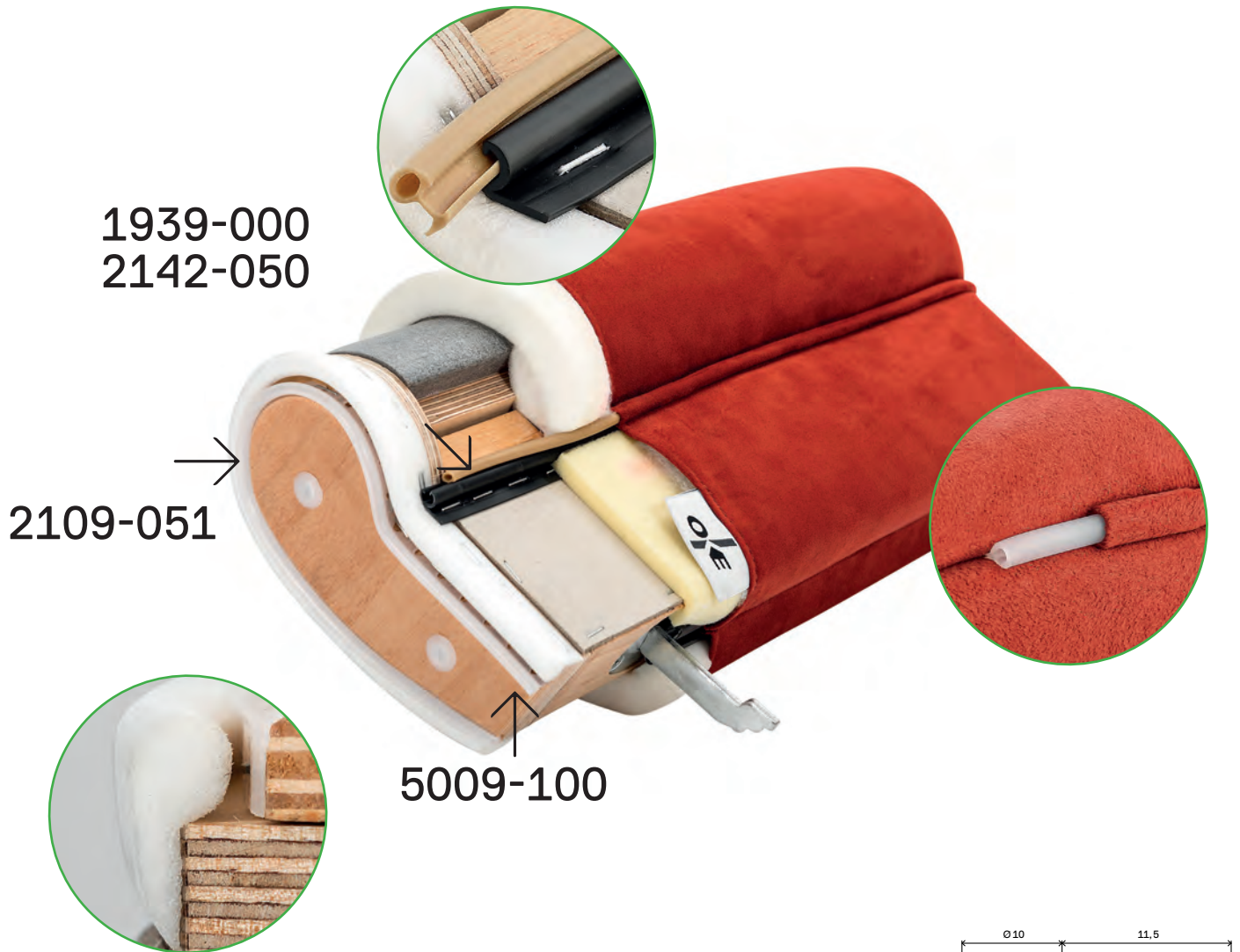

NO.	BESCHREIBUNG/DESCRIPTION
1939-000	Verschlussprofil mit Kunststoffflanke Lock profile with plastic flange
2142-050	Gegenprofil zum Einnähen Counter-bar for sewing-in

NO.	BESCHREIBUNG/DESCRIPTION
2109-051	Keder mit Kunststoffflanke Piping with plastic flange
5009-100	Schlauchkeder Edge Trim

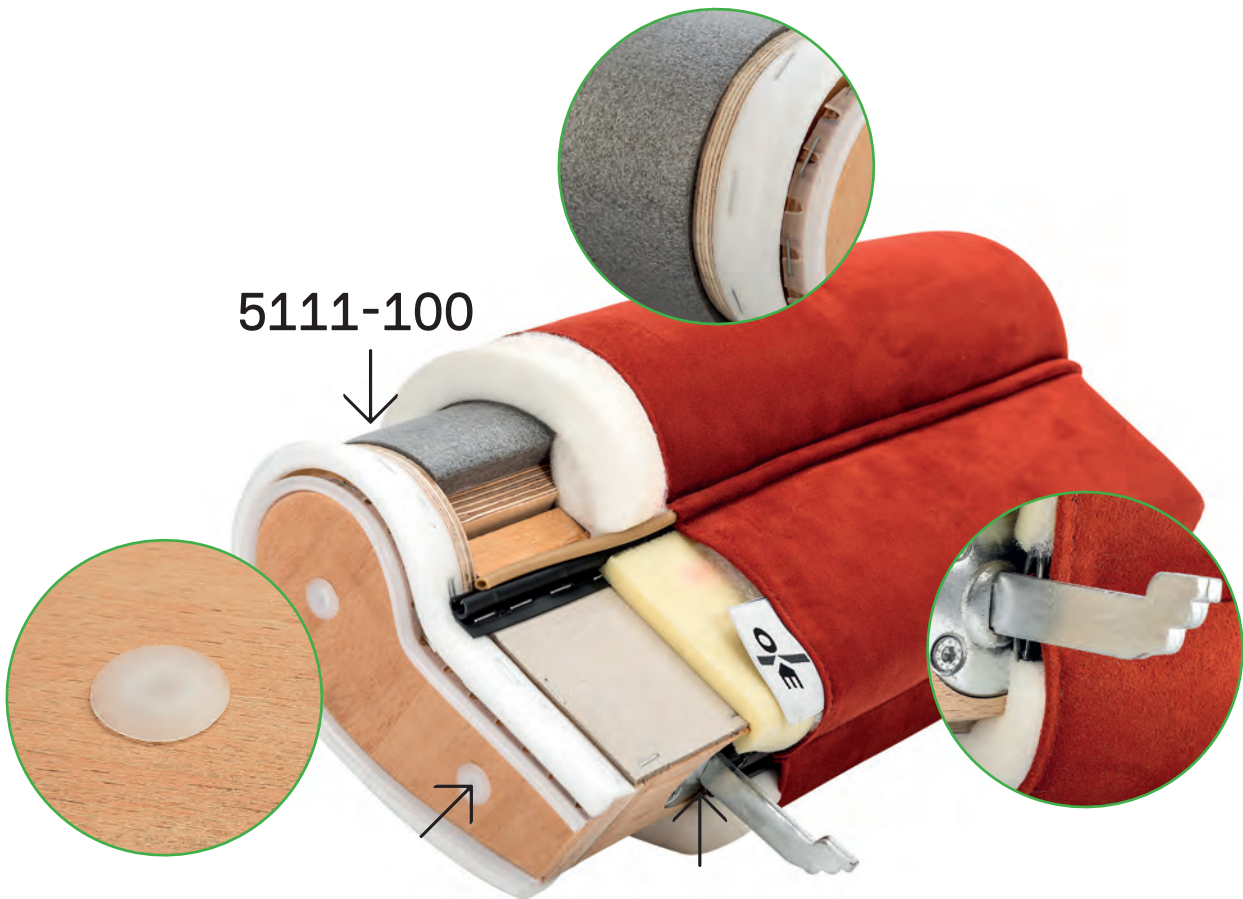

5111-100

4247-040

2023-S000
2023-510

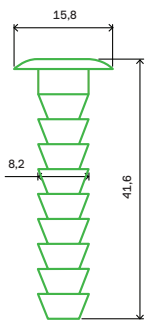

4247-040

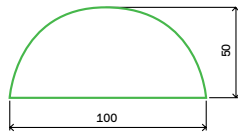

5111-100

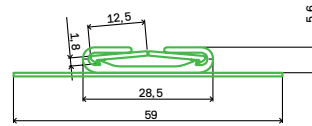

2023-S000
2023-510

NO.	BESCHREIBUNG/DESCRIPTION
4247-040	Dübel Dowel
5111-100	FoamFlex Light FoamFlex Light

NO.	BESCHREIBUNG/DESCRIPTION
2023-S000	Verschlussprofil für zwei Stoffbahnen Lock profile for two fabric panels
2023-510	Gegenleiste Counter-bar

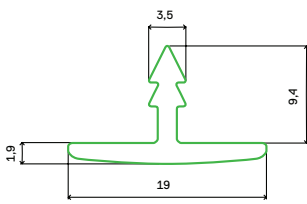
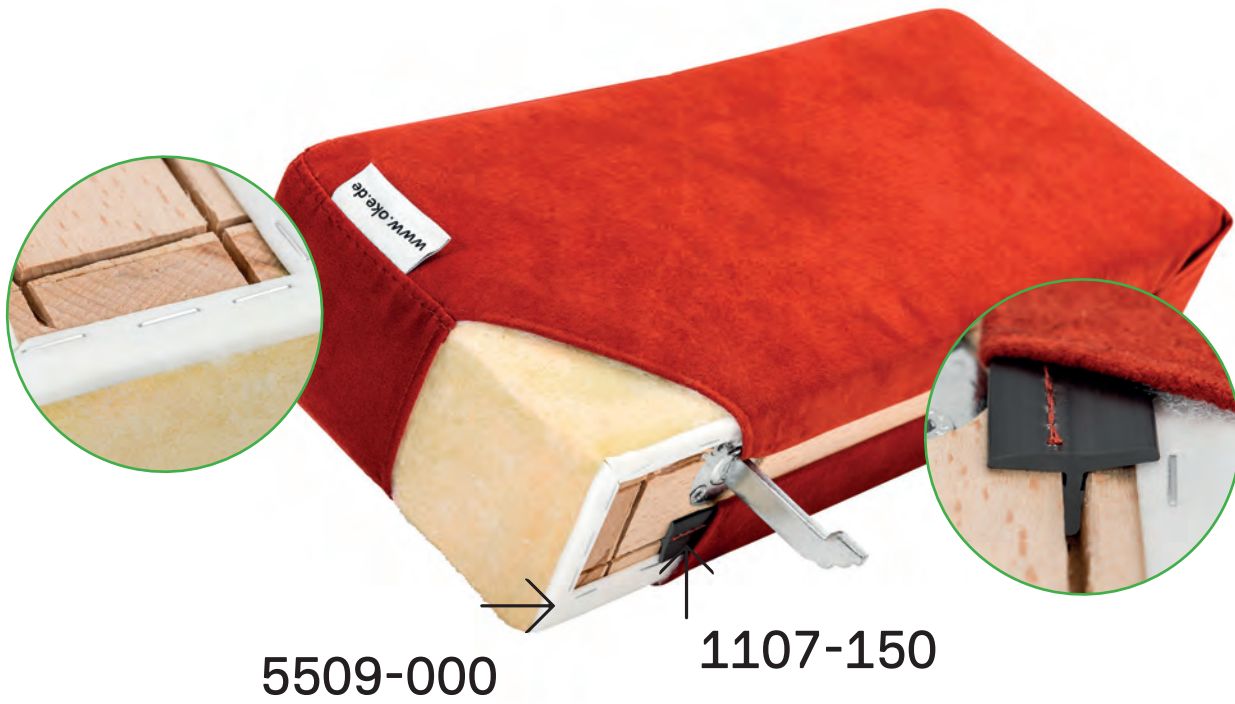

1107-150

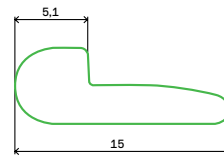

5509-000

NO.

BESCHREIBUNG/DESCRIPTION

1107-150

Keder mit Kunststoffflange
Piping with plastic flange



NO.

BESCHREIBUNG/DESCRIPTION

5509-000

Schlauchkeder
Edge Trim





2288-000
3302-999

5009-100

2271-000
2023-510

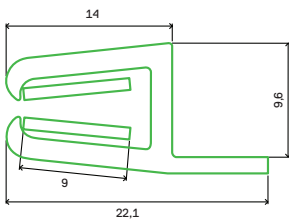

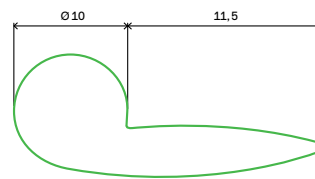

2288-000
3302-999



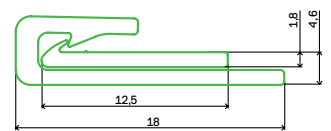

5009-100



2271-000
2023-510

NO.	BESCHREIBUNG/DESCRIPTION
2288-000	 Profil mit Kunststoffflanke Profile with plastic flange
3302-999	 Gegenleiste Counter-bar
5009-100	 Schlauchkeder Edge Trim

NO.	BESCHREIBUNG/DESCRIPTION
2271-000	 Verschlussprofil mit Widerhaken Lock profile with barb
2023-510	 Gegenleiste Counter-bar

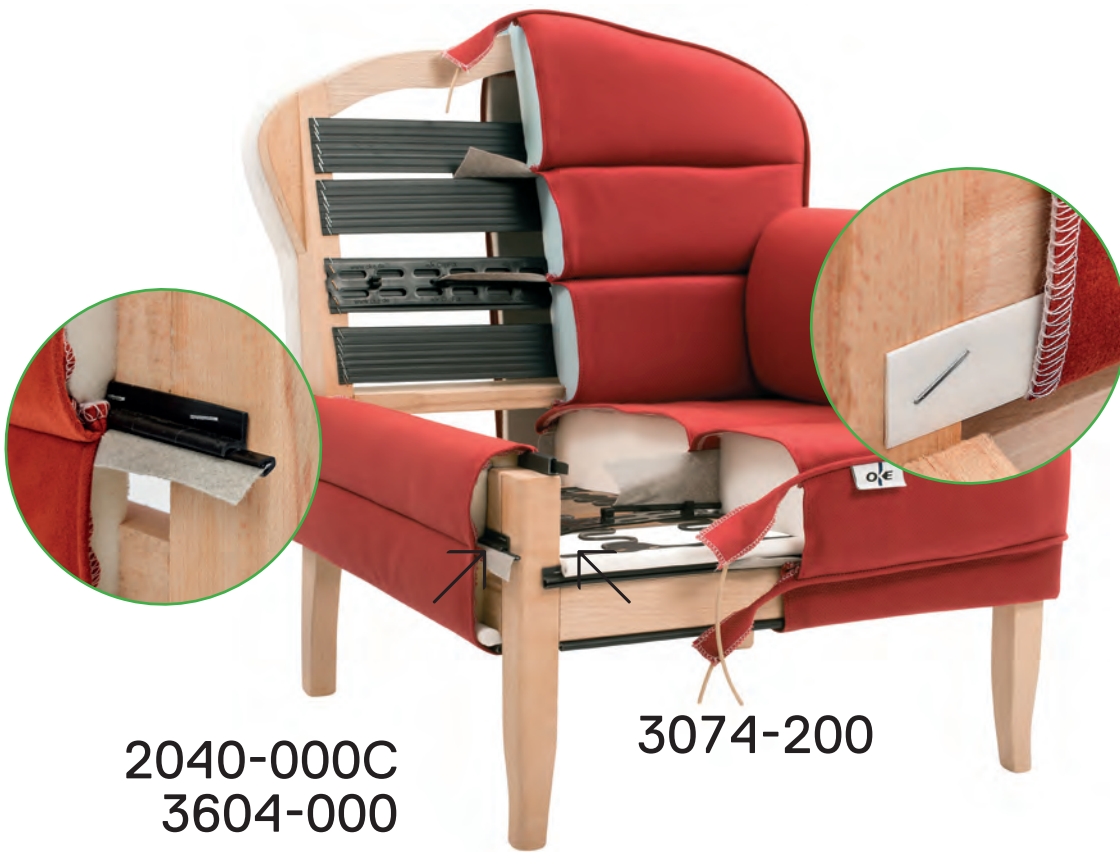

2040-000C
3604-000

3074-200

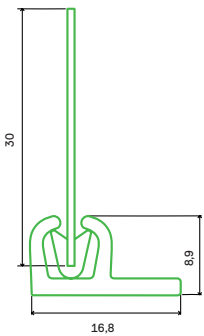

2040-000C
3604-000

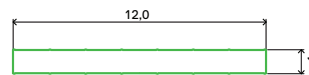

3074-200

NO.	BESCHREIBUNG/DESCRIPTION
2040-000C	Clip Profil mit Fahne und Einschnitten Clip profile with flange and cuts
3604-000	TieDown für schnelle Verarbeitung TieDown for fast processing

NO.	BESCHREIBUNG/DESCRIPTION
3074-200	Klammerstreifen mit Führungsrillen Stapling Strip with guide grooves

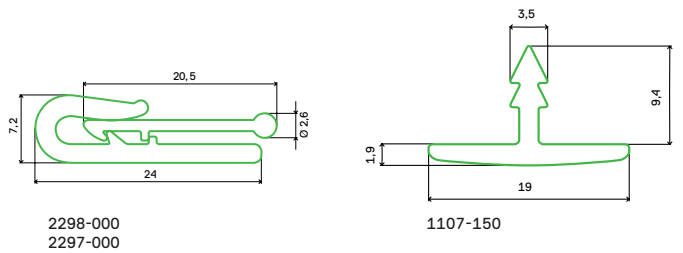
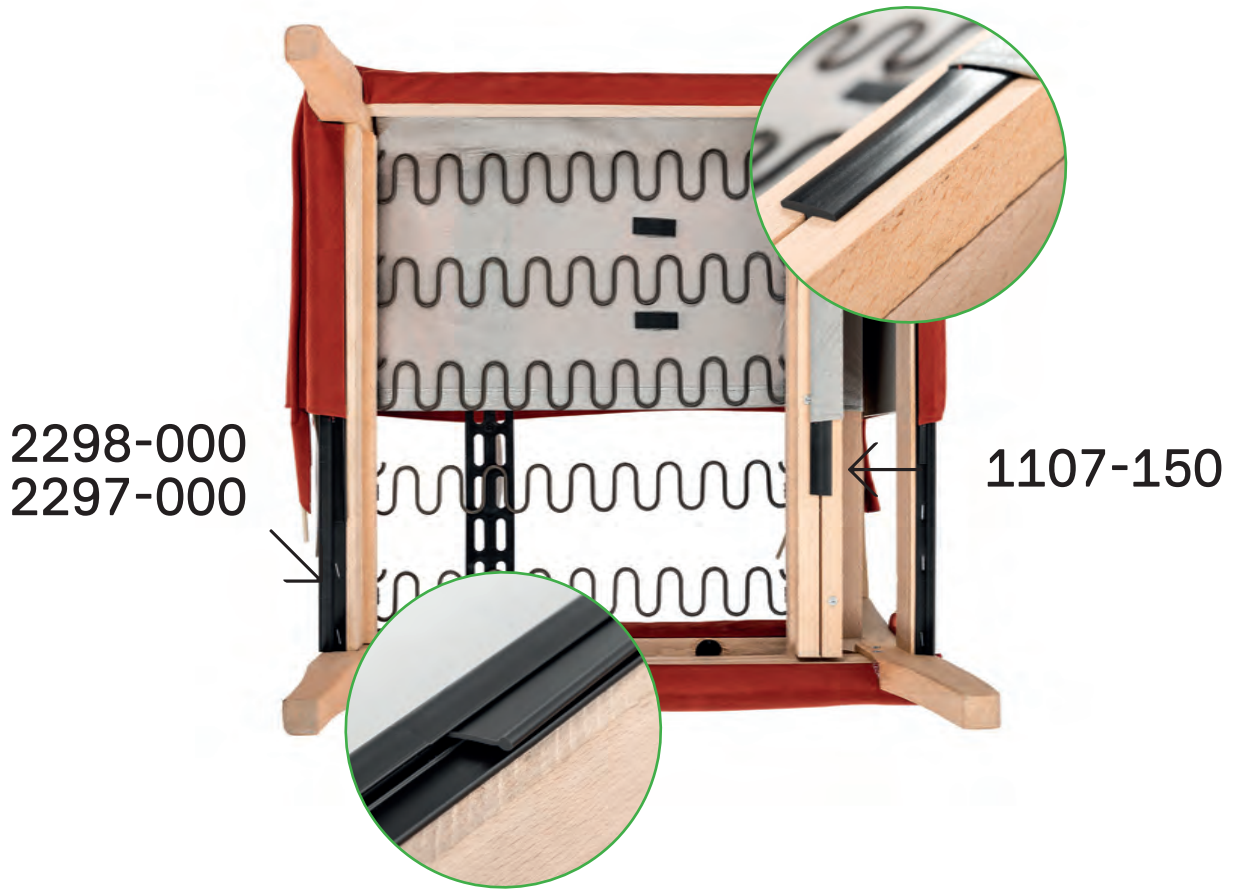

NO.	BESCHREIBUNG/DESCRIPTION
2298-000	Verschlussprofil mit Widerhaken Lock profil with barb
2297-000	Gegenleiste mit Kugel Counter-bar with ball

NO.	BESCHREIBUNG/DESCRIPTION
1107-150	Steckprofil mit Oberflächenwölbung Plug-in profile with surface curvature